

CATÁLOGO DE PRODUTOS

REF: 07/22



LEVILUX ILUMINAÇÃO E ELETRICIDADE LTDA

Rua Soldado Manassés de Aguiar
Barros, 7
Pq. Novo Mundo - São Paulo - SP
CEP: 02180-080

Telefone: (11) 2954-4511

WhatsApp: (11) 97313-9663

E-mail: vendas@levilux.com.br

Site: www.levilux.com.br

Siga-nos nas redes sociais:





DESCONTO PARA TODA A TABELA

À VISTA + **3%** DE DESCONTO

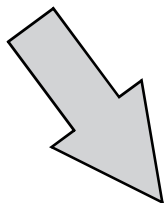

Os estados abaixo, possuem Substituição Tributária.
Segue a tabela para calcular o valor do imposto





* O estado de MT, acrescentar 11,83% no valor final de cada produto

NCM	F		G		A		B	
ESTADO	7609.0000		9405.4900		9405.1990		7306.5000	
	%	IVA	%	IVA	%	IVA	%	IVA
AL	22,88	66,00	---	---	---	---	---	---
AP	16,80	40,00	---	---	---	---	---	---
BA	22,70	65,00	---	---	---	---	---	---
DF	18,20	40,00	---	---	17,30	35,00	---	---
ES	16,80	40,00	---	---	---	---	---	---
MG	15,90	55,00	14,10	45,00	14,10	45,00	---	---
MT	22,71	74,75	---	---	---	---	---	---
PE	22,88	66,00	16,76	32,00	18,74	43,00	---	---
PR	16,44	58,00	13,02	39,00	13,02	39,00	---	---
RJ	21,20	66,00	18,40	52,00	16,60	43,00	---	---
RS	20,44	80,00	---	---	---	---	---	---
SC	---	---	---	---	---	---	---	---
SE	18,20	40,00	---	---	---	---	---	---
SP	18,00	100,00	9,90	55,00	8,46	47,00	---	---
MS	---	---	19,29	38,00	19,29	38,00	---	---



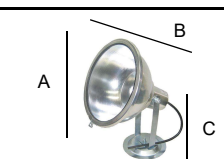

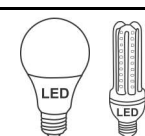
PROJETORES ESPECÍFICOS E LINHA ECONOMICA



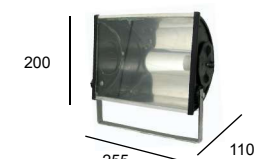
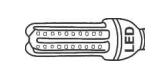
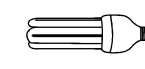

PROJETORES C/ ARO DE METAL

Dimensões	Emb	Lampadas Tipo	Watts	Soq	Código																											
						 <table border="1"> <thead> <tr> <th></th> <th>A</th> <th>B</th> <th>C</th> </tr> </thead> <tbody> <tr> <td>PA-101</td> <td>124</td> <td>150</td> <td>120</td> </tr> <tr> <td>PA-104</td> <td>190</td> <td>192</td> <td>140</td> </tr> <tr> <td>PA-107</td> <td>210</td> <td>232</td> <td>145</td> </tr> <tr> <td>PA-110</td> <td>265</td> <td>280</td> <td>200</td> </tr> <tr> <td>PA-113</td> <td>340</td> <td>330</td> <td>218</td> </tr> <tr> <td>PA-115</td> <td>340</td> <td>330</td> <td>218</td> </tr> <tr> <td>PA-117</td> <td>360</td> <td>370</td> <td>250</td> </tr> </tbody> </table>		A	B	C	PA-101	124	150	120	PA-104	190	192	140	PA-107	210	232	145	PA-110	265	280	200	PA-113	340	330	218	PA-115	340
	A	B	C																													
PA-101	124	150	120																													
PA-104	190	192	140																													
PA-107	210	232	145																													
PA-110	265	280	200																													
PA-113	340	330	218																													
PA-115	340	330	218																													
PA-117	360	370	250																													
 NCM : 9405.1990	12		7w	E-27	PA-101																											
			9w		PA-104																											
11w	PA-107																															
 Mista	1	 Vapores	160w	E-40	PA-110																											
			250w		PA-113																											
			250w	PA-115																												
			400w	PA-117																												





PROJETOR ALUMÍNIO C/ LATERAIS EM PLÁSTICO DE ENGENHARIA

Dimensões	Emb	Lampadas Tipo	Watts	Soq	Código
	6	  Eletrônica	20w	E-27	PR-129 PR (Preto)
 NCM : 9405.1990			30w		PR-129 CZ (Cinza)

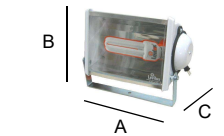

PROJETOR EM PP E POLICARBONATO P/ LAMP ELETRÔNICAS



Dimensões	Emb	Lampadas Tipo	Watts	Soq	Código
	6	  até 155mm de comprimento	12w	E-27	PR-149 PR (Preto)
 NCM : 9405.1990			30w		

PROJETORES LONGO ALCANCE (Laterais estampadas)

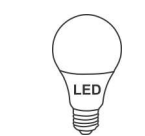
Dimensões	Emb	Lampadas Tipo	Watts	Soq	Código																				
 <table border="1"> <thead> <tr> <th></th> <th>A</th> <th>B</th> <th>C</th> </tr> </thead> <tbody> <tr> <td>PR-141*</td> <td>145</td> <td>140</td> <td>102</td> </tr> <tr> <td>PR-127</td> <td>192</td> <td>152</td> <td>102</td> </tr> <tr> <td>PR-146</td> <td>245</td> <td>152</td> <td>102</td> </tr> <tr> <td>PR-148</td> <td>260</td> <td>152</td> <td>102</td> </tr> </tbody> </table>		A	B	C	PR-141*	145	140	102	PR-127	192	152	102	PR-146	245	152	102	PR-148	260	152	102	6	  Eletrônica	9w	E-27	PR-141
	A	B	C																						
PR-141*	145	140	102																						
PR-127	192	152	102																						
PR-146	245	152	102																						
PR-148	260	152	102																						
 NCM : 9405.1990			11w	PR-127																					
			34w	PR-146																					
			42w	PR-148																					

PROJETOR EM PLÁSTICO PP P/ LÂMPADA LED BULBO A-60

Dimensões	Emb	Lampadas Tipo	Watts	Soq	Código
	1		12w	E-27	PR-149/1
 NCM : 9405.1990					

Dimensões	Emb	Lampadas Tipo	Watts	Soq	Código
	1		24w	2x E-27	PR-149/2
 NCM : 9405.1990					

ARANDELAS









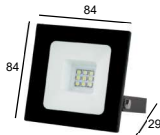

ARANDELA RETANGULAR BRANCA P/ BRAÇOS CURVOS								
Dimensões	Acab.	Emb	Lamp. Tipo	Watts	Soq	Encaixe	Código	
 NCM : 9405.1990		Em chapa de alumínio Laterias pintado epoxi Branco	6  LED  Eletrônica	11w	E-27	25mm	LM-280	
				30w			LM-283 (c/ braço)	
ARANDELA COM BRAÇO - HASTE ARTICULADA								
Dimensões	Emb	Lamp. Tipo	Watts	Soq	Encaixe	Código		
 NCM : 9405.1990	 10	 LED  Eletrônica	11w 30w	E-27	3/8"	AR-421		
ARANDELA COMPLETA C/ BRAÇO CURVO DE 30CM								
Dimensões	Acab.	Emb	Lamp. Tipo	Watts	Soq	Encaixe	Código	
 NCM : 9405.1990	 AR-411 220  AR-410 260	- Em alumínio escovado - Soquete E-27 - Braço curvo 30cm (BR-509)	 LED  Eletrônica	11w	E-27	3/8"	AR-411	
				30w			AR-411E (Sem banho)	
		20					AR-410 AR-410E (Sem banho)	
ARANDELA COMPLETA C/ BRAÇO RETO DE 30CM								
Dimensões	Acab.	Emb	Lamp. Tipo	Watts	Soq	Encaixe	Código	
 NCM : 9405.1990	 AR-413 220  AR-412 260	- Em alumínio escovado - Soquete E-27 - Braço reto 30cm (BR-508)	 LED  Eletrônica	11w	E-27	3/8"	AR-413	
				30w			AR-412	
ARANDELA COMPLETA C/ BRAÇO CURVO DE 30CM								
Dimensões	Acab.	Emb	Lamp. Tipo	Watts	Soq	Encaixe	Código	
 NCM : 9405.1990	 240	- Em alumínio escovado - Soquete E-27 - Braço curvo 30cm (BR-509)	 LED  Eletrônica	11w 30w	E-27	3/8"	AR-415	

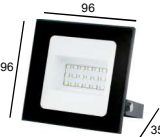
REFLETORES INDUSTRIAIS

REFLETOR INDUSTRIAL EM ALUMÍNIO (MODELO FUNDO) - ABERTO									
Dimensões		Furação	Emb	Lamp. Tipo	Watts	Soq	Diametro	Código	
 NCM : 9405.1990		45 mm	10	 LED  Eletrônica	16w	-O-	12"	RE-301	
					54w		14"	RE-302	
					54w		16"	RE-303	
REFLETOR INDUSTRIAL EM ALUMÍNIO (MODELO RASO) - ABERTO									
Dimensões		Furação	Emb	Lamp. Tipo	Watts	Soq	Diametro	Código	
 NCM : 9405.1990		45 mm	10	 Mista	160w	--O--	10"	RE-300	
					250w		12"	RE-331	
					250w		14"	RE-332	
					400w		16"	RE-333	
					400w		16"	RE-333	
REFLETOR IND. TIPO BEDD C/ FLANGE DE ALUMÍNIO FUNDIDO - ABERTO									
Dimensões		Entrada	Emb	Lamp. Tipo	Watts	Soq	Diametro	Código	
 NCM : 9405.1990		3/8" Ou 1/2"	10	 Mista  Vapores	160w	E-27	12"	RE-309	
					250w		14"	RE-310	
					500w		16"	RE-312	
					250w		14"	RE-311	
					400w		16"	RE-313	
					400w		16"	RE-313	
FLANGE ADAPTADORA C/ SOQUETE				UTILIZAÇÃO					
Tipo / Rosca	Soquete	Gancho	Código			Estas flanges são em alumínio fundido. Compatíveis c/ quaisquer tipo de soquetes. Poderão ser utilizadas nos refletores tipo BEDD (modelos acima) - RE-301/302/303 (Fundos) - RE-300/331/332/333 (Rasos)			
3/8"	- o -	- o -	FL-950						
1/2"	- o -	- o -	FL-951						
3/4"	- o -	- o -	FL-952						
3/8"	E-27	- o -	FL-950/27						
3/8"	E-40	- o -	FL-950/40						
1/2"	E-27	- o -	FL-951/27						
1/2"	E-40	- o -	FL-951/40						
3/4"	E-27	Sim	FL-952/27						
3/4"	E-40	Sim	FL-952/40						
PRATO EM ALUMÍNIO									
Dimensões		Descriç.	Entrad	Emb	Lamp. Tipo	Watts	Soq	Diametro	Código
 NCM : 9405.1990	PF-401	---	---	10	 LED  LED	11w	---	10"	PF-401
	PF-402	c/ soquete e flange	3/8"						PF-402
BRAÇOS PARA SEREM UTILIZADOS COM OS PRATOS BEDD									
Dimensões			Entrada	Acabamento	Emb	Código			
 NCM : 7306.5000	BR-508	BR-509	3/8"	Eletrolítico	10	BR-508			
	BR-508	BR-509				BR-510	Pintado (verde)	10	BR-510
300	300	600							

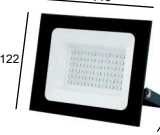

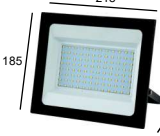

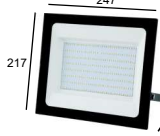

LINHA LED REFLETORES SLIM

		REFLETOR LED 10W - BIVOLT - 3000K / 6500K							
		Dimensões	Emb	IRC	Fluxo	FATOR DE POTENCIA	Vida Útil	Eficiência	Código
 NCM : 9405.1990		1	≥0,80	750 lm	≥0,50	25.000 Horas	75 lm / W	PR-160/10	
		REFLETOR LED 20W - BIVOLT - / 6500K							
		Dimensões	Emb	IRC	Fluxo	FATOR DE POTENCIA	Vida Útil	Eficiência	Código
 NCM : 9405.1990		1	≥0,80	1500 lm	≥0,50	25.000 Horas	75 lm / W	PR-160/20	
		REFLETOR LED 30W - BIVOLT - 3000K / 6500K							
		Dimensões	Emb	IRC	Fluxo	FATOR DE POTENCIA	Vida Útil	Eficiência	Código
 NCM : 9405.1990		1	≥0,80	2250 lm	≥0,50	25.000 Horas	75 lm / W	PR-160/30	
		REFLETOR LED 50W - BIVOLT - 3000K / 4000K / 6500K							
		Dimensões	Emb	IRC	Fluxo	FATOR DE POTENCIA	Vida Útil	Eficiência	Código
 NCM : 9405.1990		1	≥0,80	3750 lm	≥0,50	25.000 Horas	75 lm / W	PR-160/50	
		REFLETOR LED 100W - BIVOLT - 3000K / 6500K							
		Dimensões	Emb	IRC	Fluxo	FATOR DE POTENCIA	Vida Útil	Eficiência	Código
 NCM : 9405.1990		1	≥0,80	7500 lm	≥0,50	25.000 Horas	75 lm / W	PR-160/100	
		REFLETOR LED 150W - BIVOLT - 6500K							
		Dimensões	Emb	IRC	Fluxo	FATOR DE POTENCIA	Vida Útil	Eficiência	Código
 NCM : 9405.1990		1	≥0,80	11250 lm	≥0,50	25.000 Horas	75 lm / W	PR-160/150	

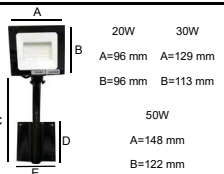
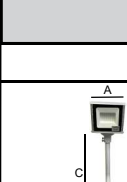
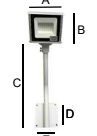

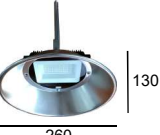
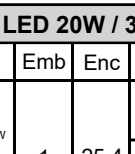
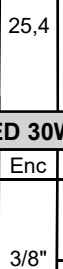
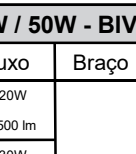
LINHA LED LUMINÁRIAS E HIGH BAY LED

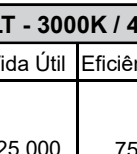
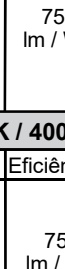
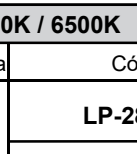
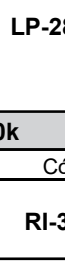
		LUMINÁRIA LED 20W / 30W / 50W - BIVOLT - 3000K / 4000K / 6500K							
		Dimensões	Emb	Enc	Fluxo	Braço	Vida Útil	Eficiência	Código
 NCM : 9405.1990		20W 30W A=96 mm A=129 mm B=96 mm B=113 mm	1	25,4	20W 1500 lm	30 cm	25.000 Horas	75 lm / W	LP-289/20
		20W / 30W / 50W C=300 mm			30W 2250 lm				LP-289/30
		50W A=148 mm B=122 mm			50W 3750 lm				LP-289/50
		LUMINÁRIA LED 50W - BIVOLT - 3000K / 4000K / 6500K							
		Dimensões	Emb	Enc	Fluxo	Braço	Vida Útil	Eficiência	Código
 NCM : 9405.1990		A=129 mm B=113 mm C=500 mm D=130 mm E=130 mm	1	25,4	2250 lm	50 cm	25.000 Horas	75 lm / W	LP-288/LED
		HIGH BAY LED 30W / 50W - BIVOLT - 3000K / 4000K / 6500k							
		Dimensões	Emb	Enc	Fluxo	Braço	Vida Útil	Eficiência	Código
 NCM : 9405.1990		260	1	3/8"	30W 2250 lm	Reto (30 cm) ou	25.000 Horas	75 lm / W	RI-315/30
					50W 3750 lm	Gancho de Fixação			RI-315/50
		LUMINÁRIA PÚBLICA LED 50W BIVOLT - 6500K (IP-66)							
		Dimensões	Emb	Enc	Fluxo	Temp.	Vida Útil	Eficiência	Código
 NCM : 9405.4900		466	1	40	6883 lm	-40° C a +50° C	50.000 Horas	114 lm / W	LX-050
		LUMINÁRIA PÚBLICA LED 100W BIVOLT - 6500K (IP-66)							
		Dimensões	Emb	Enc	Fluxo	Temp.	Vida Útil	Eficiência	Código
 NCM : 9405.4900		466	1	50	14300 lm	-40° C a +50° C	50.000 Horas	143 lm / W	LX-100
		LUMINÁRIA PÚBLICA LED 150W BIVOLT - 6500K (IP-66)							
		Dimensões	Emb	Enc	Fluxo	Temp.	Vida Útil	Eficiência	Código
 NCM : 9405.4900		466	1	50	22275 lm	-40° C a +50° C	50.000 Horas	148 lm / W	LX-150
		LUMINÁRIA PÚBLICA LED 50W / 100W / 120W / 150W BIVOLT - 3000K / 4000K / 5000K - (IP-66)							
		Dimensões	Emb	Enc	Fluxo	Temp.	Vida Útil	Eficiência	Código
 NCM : 9405.4900		530	1	70	12160 lm	-20° C a +45° C	50.000 Horas	152 L/W	LL-050
					15200 lm				LL-100
					18240 lm				LL-120
					22500 lm				LL-150



BLINDADOS À PROVA DE PÓS, GASES E VAPORES E CAIXAS DE PASSAGEM

 <small>NCM : 9405.1990</small>	BLINDADO TIPO PENDENTE									
	A	B		Emb	Lampadas Tipo	Watts	Soq	Código		
	145	110			1		30w	E-27	BL-701	
	225	134	 Mista			160w	BL-702			
	256	160				250w	BL-720			
 <small>NCM : 9405.1990</small>	BLINDADO TIPO PLAFOUNIER									
	A	B		Emb	Lampadas Tipo	Watts	Soq	Código		
	145	110			1		30w	E-27	BL-703	
	225	134	 Mista			160w	BL-704			
	256	160				250w	BL-721			
 <small>NCM : 9405.1990</small>	BLINDADO 45 GRAUS									
	A	B		Emb	Lampadas Tipo	Watts	Soq	Código		
	145	110			1		30w	E-27	BL-705	
	225	134	 Mista			160w	BL-706			
	256	160				250w	BL-722			
 <small>NCM : 9405.1990</small>	BLINDADO 90 GRAUS									
	A	B		Emb	Lampadas Tipo	Watts	Soq	Código		
	145	110			1		30w	E-27	BL-707	
	225	134	 Mista			160w	BL-708			
	256	160				250w	BL-723			
 <small>NCM : 9405.1990</small>	BLINDADO P/ EMBUTIR EM ALUMÍNIO OU POLICARBONATO (GRADE FUNDIDA)									
	Dimensões			Emb	Lampadas Tipo	Watts	Soq	Código		
	 <small>BL-711</small>			1	 LED	13w	E-27	BL-710		
	 <small>BL-712</small>				 Eletrónica	32w		E-27	BL-711 (injetado)	
 <small>BL-712</small>			 Mista		160w	BL-712/PL c/ Soqueteira				
 <small>NCM : 9405.1990</small>	BLINDADO TIPO TARTARUGA									
	Dimensões			Emb	Lampadas Tipo	Watts	Soq	Código		
			1	 LED	9w	E-27	BL-709 <i>FUNDIDO</i>			
 <small>NCM : 9405.1990</small>	SINALIZADORES (MACROLON)			 <small>NCM : 7609.0000</small>			CAIXA PASSAGEM ANTI-DERRAPANTE			
	Lâmp	Cor	Código				Emb.	Cor	Código	
		Vermelho	BL-726				6	10X10X6	CL-630	
	Emb.	Amarelo	BL-727						15X15X10	CL-631
		Azul	BL-728						20X20X10	CL-632
Branco		BL-729	30X30X12	CL-633						
Verde		BL-730	40X40X12	CL-634						

LUMINÁRIAS P/ ILUMINAÇÃO PÚBLICA

LUMINÁRIA PÚBLICA ABERTA (PADRÃO)

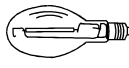
Dimensões	Emb	Enc	Lampadas Tipo	Watts	Soq	Código	
 420 110 280	5	25	 Vapores	70w a 250w	E-27	LP-270	
		33				LP-271	
		25				E-40	LP-270/40
		33					LP-271/40

NCM : 9405.4900

LUMINÁRIA PÚBLICA C/ TELA DE PROTEÇÃO

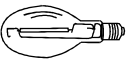
Dimensões	Emb	Enc	Lampadas Tipo	Watts	Soq	Código	
 420 140 280	5	25	 Vapores	70w a 250w	E-27	LP-272	
		33				LP-273	
		25				E-40	LP-272/40
		33					LP-273/40

NCM : 9405.4900

LUMINÁRIA PÚBLICA ABERTA

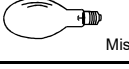
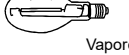
Dimensões	Emb	Enc	Lampadas Tipo	Watts	Soq	Código
 375 130 295	5	25	 Mista	250w a 400w	E-40	LP-260/25
		33				LP-260/33
		48	 Vapores			LP-260/48
		65				LP-260/60

NCM : 9405.4900

LUMINÁRIAS KIT (LUMINÁRIA + BRAÇO)

LUMINÁRIA PÚBLICA FECHADA C/ POLICARBONATO + BRAÇO 30CM

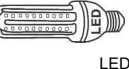
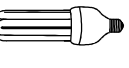

Dimensões	Emb	Enc	Lampadas Tipo	Watts	Soq	Código
 335 175 195 Braço 30cm (Galvanizado)	1	25	 LED  Eletrônica	11w	E-27	KIT-288
				30w		

NCM : 9405.4900

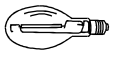
LUMINÁRIA PÚBLICA TREVO FECHADA C/ POLICARBONATO

Dimensões	Lampadas Tipo	Watts	Pétalas	Código
 NCM : 9405.4900	 Vapores	250w a 400w	01	LP-291/1
		Soq	02	LP-291/2
			03	LP-291/3
			04	LP-291/4

LUMINÁRIA PÚBLICA TREVO FECHADA C/ POLICARBONATO E ALOJAMENTO

Dimensões	Lampadas Tipo	Watts	Pétalas	Código
 NCM : 9405.4900	 Vapores	250w	01	LP-292/1
		Soq	02	LP-292/2
			03	LP-292/3
			04	LP-292/4

LUMINÁRIAS P/ ILUMINAÇÃO PÚBLICA (fechada com policarbonato)

LUMINÁRIA PÚBLICA FECHADA C/ POLICARBONATO									
Dimensões	Emb	Enc	Lampadas Tipo	Watts	Soq	Código			
 NCM : 9405.4900		5	25	 Vapores	70/80w	E-27	LP-288		
			33	 Vapores	150w	E-40	LP-289		
LUMINÁRIA PÚBLICA FECHADA C/ POLICARBONATO									
Dimensões	Emb	Enc	Lampadas Tipo	Watts	Soq	Código			
 NCM : 9405.4900		2	25	 Vapores	150w	E-40	LP-276/25		
			33		a 250w		LP-276/33		
			48				LP-276/48		
LUMINÁRIA PÚBLICA FECHADA C/ POLICARBONATO									
Dimensões	Emb	Enc	Lampadas Tipo	Watts	Soq	Código			
 NCM : 9405.4900		1	25	 Vapores	250w	E-40	LP-261/25		
			33		a 400w		LP-261/33		
			48				LP-261/48		
			65				LP-261/60		
LUMINÁRIA PÚBLICA FECHADA C/ POLICARBONATO									
Dimensões	Emb	Enc	Lampadas Tipo	Watts	Soq	Código			
 NCM : 9405.4900		1	25	 Mistas	até 250w	E-27	LP-252/25		
			33				LP-252/33		
			48				LP-252/48		
			25	 Vapores			E-40	LP-253/25	
			33					LP-253/33	
			48					LP-253/48	
LUMINÁRIA PÚBLICA FECHADA C/ POLICARBONATO									
Dimensões	Emb	Enc	Lampadas Tipo	Watts	Soq	Código			
 NCM : 9405.4900		1	48	 Vapores	até 250w	E-40	LP-276/60		
			até 60 mm						
LUMINÁRIA PÚBLICA ABERTA									
Dimensões	Emb	Enc	Lampadas Tipo	Watts	Soq	Código			
 NCM : 9405.4900		1	48	  Vapores	até 400w	E-40	LM-254/60		
			até 60 mm						



LUMINÁRIAS P/ ILUMINAÇÃO PÚBLICA

LUMINÁRIA OVAL ABERTA (TIPO ECONÔMICA)							
Dimensões	Emb	Encaixe	Lampadas Tipo	Watts	Soq	Código	
<p>LM-254 = 100 LM-256 = 140 LM-257 = 140</p> <p>NCM : 9405.4900</p>	6	25mm	 LED Eletrônica Mista Vapores	16w 34w 250w 80w	E-27	LM-254 (ABERTA) LM-256 (C/ VIDRO) LM-257 (C/ TELA)	

LUMINÁRIA OVAL ABERTA (REFORÇADA)							
Dimensões	Emb	Encaixe	Lampadas Tipo	Watts	Soq	Código	
<p>NCM : 9405.4900</p>	6	25mm	 Mista	250w	E-27	LM-201 LM-203/25	
	6	33mm 48mm				LM-203/33 LM-203/48	
	6	25mm 33mm 48mm	 Vapores	E-40	LM-204/25 LM-204/33 LM-204/48		





LUMINÁRIA OVAL FECHADA C/ VIDRO (CANELADO)							
Dimensões	Emb	Encaixe	Lampadas Tipo	Watts	Soq	Código	
<p>NCM : 9405.4900</p>	1	25mm 33mm 48mm	 Mista	250w	E-27	LM-205/25 LM-205/33 LM-205/48	
		25mm 33mm 48mm				 Vapores	E-40

LUMINÁRIA OVAL FECHADA C/ TELA (GALVANIZADA)							
Dimensões	Emb	Encaixe	Lampadas Tipo	Watts	Soq	Código	
<p>NCM : 9405.4900</p>	1	25mm 33mm 48mm	 Mista	250w	E-27	LM-250/25 LM-250/33 LM-250/48	
		25mm 33mm 48mm				 Vapores	E-40







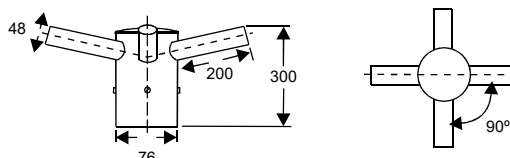



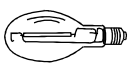

ADAPTADOR PARA BRAÇO DE LUMINÁRIA (PARAFUSOS SEXTAVADOS)							
Dimensões	A	B	C	D	Código		
<p>NCM : 9405.1990</p>	35	45	85	60	AD-947		
	35	45	85	48	AD-948		
	48	50	65	60	AD-949		

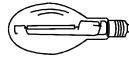
* - Todos os modelos , o Fechamento é com Presilha em Arame Galvanizado

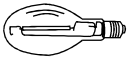
BRAÇOS E SUPORTES P/ LUMINARIAS E REFLETORES

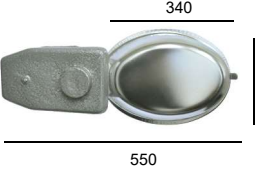
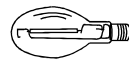
MODELOS	ACABAMENTO	COMP (metros)	∅ (mm)	CÓDIGO
SUPOORTE P/ LUMINÁRIA C/ SAPATA				
 NCM : 7306.5000	Eletrolítico a Fogo Pintado Epoxi	0,50	25	SB-511 SB-512 SB-513
	Eletrolítico a Fogo	1,00	25	SB-514 SB-524
SUPOORTE P/ LUMINÁRIA C/ SAPATA				
 NCM : 7306.5000	Eletrolítico a Fogo	1,00	25	SB-501 SB-502
	Eletrolítico a Fogo	1,50	25	SB-503 SB-504
	Eletrolítico a Fogo	2,00	25	SB-521 SB-522
SUPOORTE P/ LUMINÁRIA C/ SAPATA				
 NCM : 7306.5000	a Fogo	1,50	25	SB-525/15
		2,00		SB-525/20
		2,50		SB-525/25
	a Fogo	1,50	33	SB-533/15
		2,00		SB-533/20
		2,50		SB-533/25
	a Fogo	1,00	48	SB-548/10
		1,50		SB-548/15
		2,00		SB-548/20
a Fogo	2,50	48	SB-548/25	
	3,00		SB-548/30	
SUPOORTE P/ LUMINÁRIA C/ SAPATA				
 NCM : 7306.5000	a Fogo	1,00	25	SB-532/10
		1,50		SB-532/15
		2,00		SB-532/20
	a Fogo	1,50	33	SB-534/15
		2,00		SB-534/20
		2,50		SB-534/25
		3,00		SB-534/30
	a Fogo	1,50	48	SB-507/15
		2,00		SB-507/20
	3,00		SB-507/30	
SUPOORTE P/ LUMINARIA (TIPO TREVO)				
 NCM : 7306.5000	Código	Enc.		
	SB-530/1	∅ 76 (mm)		
	SB-530/2			
	SB-530/3			
	SB-530/4			

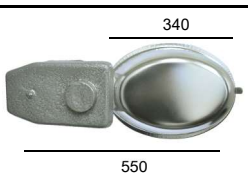
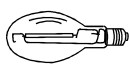

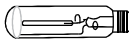
LUMINÁRIAS P/ ILUMINAÇÃO PÚBLICA (fechada e com ALOJAMENTO)

LUMINÁRIA PÚBLICA FECHADA C/ POLICARBONATO							
Dimensões	Emb	Enc	Lampadas Tipo	Watts	Soq	Código	
 NCM : 9405.4900 	01	até 63	 Vapores	70w a 150w	E-27 ou E-40	LP-278	
LUMINÁRIA PÚBLICA FECHADA C/ POLICARBONATO							
Dimensões	Emb	Enc	Lampadas Tipo	Watts	Soq	Código	
 NCM : 9405.4900 	01	até 63	 Vapores	70w a 150w	E-27 ou E-40	LP-277/25	
LUMINÁRIA PÚBLICA FECHADA C/ POLICARBONATO							
Dimensões	Emb	Enc	Lampadas Tipo	Watts	Soq	Código	
 NCM : 9405.4900 	01	até 63	 Vapores	150 a 250w	E-40	LP-262/25	
LUMINÁRIA PÚBLICA FECHADA C/ VIDRO CANELADO							
Dimensões	Emb	Enc	Lampadas Tipo	Watts	Soq	Código	
 NCM : 9405.4900 	01	até 63	 Vapores	150	E-40	LP-228/VD	
LUMINÁRIA PÚBLICA FECHADA C/ POLICARBONATO							
Dimensões	Emb	Enc	Lampadas Tipo	Watts	Soq	Código	
 NCM : 9405.4900 	01	até 63	 Vapores	150	E-40	LP-228/25	
LUMINÁRIA PÚBLICA FECHADA COM ALOJAMENTO VIDRO PLANO							
Dimensões	Emb	Enc	Lampadas Tipo	Watts	Soq	Código	
 NCM : 9405.4900 	01	até 63	 Somente Tubulares	250w	E-40	LP-264	



REFLETORES INDUSTRIAIS (Sem Alojamento)

EM ACRÍLICO

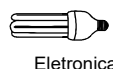
Dimensões	Ent / Rosca	Emb	Lamp. Tipo	Watts	Soq	Fechamento	Código
 RI-355G = 410 (16") RI-357 = 550 (22")	1/2" ou 3/4"	1	 LED  Electronica	18w até 105w	E-27 E-40	Aberta	RI-355G
							Gancho p/ fixação perfilados

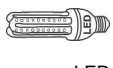
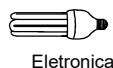

NCM : 9405.1990

EM ACRÍLICO

Dimensões	Ent / Rosca	Emb	Lamp. Tipo	Watts	Soq	Fechamento	Código
 410 (16")	1/2" ou 3/4"	1	 LED  Electronica	18w até 105w	E-27 ou E-40	Aberta	RI-355



NCM : 9405.1990

REFLETOR INDUSTRIAL EM ALUMÍNIO S/ ALOJAMENTO

Dimensões	Ent / Rosca	Emb	Lamp. Tipo	Watts	Soq	Fechamento	Código
 400 450 18" (diam)	1/2" ou 3/4"	1	 V.Sódio V.Metálico	250w ou 400w	E-40	Aberta	RI-340
						c/ Vidro	RI-341
						c/ Tela	RI-342



NCM : 9405.1990

REFLETOR INDUSTRIAL EM ALUMÍNIO FOSCO

Dimensões	Ent / Rosca	Emb	Lamp. Tipo	Watts	Soq	Fechamento	Código
 482 430 16" (diam)	1/2" ou 3/4"	1	 Vapores	250W	E-40	Aberta	RI-370
						c/ Vidro	RI-371

NCM : 9405.1990

REFLETOR INDUSTRIAL EM ALUMÍNIO S/ ALOJAMENTO

Dimensões	Ent / Rosca	Emb	Lamp. Tipo	Watts	Soq	Fechamento	Código
 400 508 20" (diam)	1/2" e	1	 V.Sódio V.Metálico	250w ou 400w	E-40	Aberta	RI-323
						C/ Vidro	RI-325
						C/ Tela	RI-324

NCM : 9405.1990



REFLETORES INDUSTRIAIS (Com Alojamento)

EM ALUMÍNIO ANODIZADO C/ ALOJAMENTO EM CHAPA DE AÇO



NCM : 9405.1990

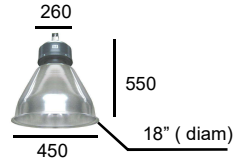

Ent / Rosca	Emb	Lamp. Tipo	Watts	Soq	Fechamento	Código
1/2" ou 3/4"	1	 V.Sódio V.Metálico	250w ou 400w	E-40	Aberta	RI-343
Gancho					c/ Vidro	RI-344
p/ fixação perfilados					c/ Tela	RI-345

EM ALUMÍNIO ANODIZADO C/ ALOJAMENTO EM CHAPA DE AÇO



NCM : 9405.1990

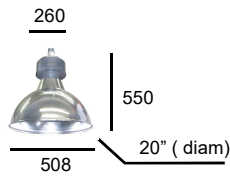

Ent / Rosca	Emb	Lamp. Tipo	Watts	Soq	Fechamento	Código
1/2" e	1	 V.Sódio V.Metálico	até 400w	E-40	Aberta	RI-326
Gancho					c/ Vidro	RI-327
p/ fixação perfilados					c/ Tela	RI-328

EM ALUMÍNIO ANODIZADO FOSCO C/ ALOJAMENTO EM CHAPA DE AÇO



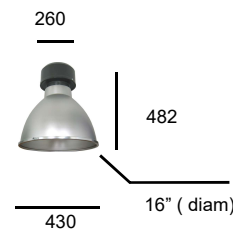

NCM : 9405.1990





Ent / Rosca	Emb	Lamp. Tipo	Watts	Soq	Fechamento	Código
1/2" e	1	 Vapores	até 250w	E-40	Aberta	RI-373
Gancho					c/ Vidro	RI-374
p/ fixação perfilados						

REFLETORES PENDENTES

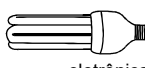

EM ALUMÍNIO (VERDE EXTERNO E BRANCO INTERNO)

 NCM : 9405.1990	A	B	Diâmetro	Emb	Fixação	Lampadas Tipo	Watts	Soq	Código
	260	100	10"	06	P E N D E N T E	 LED	11w	E-27	AR-417 AR-418 AR-419 AR-420
	300	155	12"						
	350	185	14"						
	410	220	16"						
c/ Cabo PP de 1,20 mts					 eletrônica	até 54w			

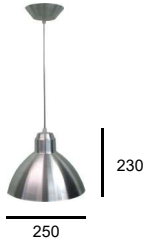

EM ALUMÍNIO ESCOVADO

 NCM : 9405.1990	Dimensões		Emb	Fixação	Lampadas Tipo	Watts	Soq	Código
	 300 (12") 235		01	P E N D E N T E	 LED	16w	E-27	RI-354AE
	c/ Cabo PP de 1,20 mts							



EM ALUMÍNIO (COLORIDO)

 NCM : 9405.1990	Dimensões		Emb	Fixação	Lampadas Tipo	Watts	Soq	Código
	 250 230		01	P E N D E N T E	 LED	16w	E-27	RI-376ES (Escovado) RI-376BR (Branco) RI-376PT (Preto)
	c/ Cabo PP de 1,20 mts							

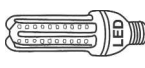
EM ACRÍLICO INJETADO

 NCM : 9405.1990	Dimensões		Emb	Fixação	Lampadas Tipo	Watts	Soq	Código
	 RI-354P = 310 RI-355P = 345		06	P E N D E N T E	 LED	16w	E-27	RI-354P
	RI-354P = 300 (12") RI-355P = 410 (16") c/ Cabo PP de 1,20 mts		01					

EM ACRÍLICO MOLDADO COM LENTE DE PROTEÇÃO

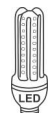
 NCM : 9405.1990	Dimensões		Emb	Fixação	Lampadas Tipo	Watts	Soq	Código	
	c/ Cabo PP de 1,00 mt 		10		 LED	 LED	até 60w	E-27	CB-810
	Soquete Canopla								

CAIXAS P/ PISO E TAMPAS

  NCM : 7609.0000	CAIXAS P/ PISO COMPLETA 4X2 (CAIXA + TAMPA + TOMADAS) LATÃO		  NCM : 7609.0000	TAMPAS EM CHAPA DE LATÃO SEM EQUIPAMENTO (4X2) LATÃO		
	C/ Equipamento	Código		Descrição	Código	
	1 Tom Univ 2 Polos	CP-601		Cega	TP-615	
	1 Tom Telebrás	CP-602		1 Unha Redonda	TP-617	
	1 Tom Univ 2P + T	CP-603		1 Unha Quadrada	TP-623	
	2 Tom RJ-45 11 amp	CP-628		2 Tom RJ-45	TP-627	
 NCM : 7609.0000	CAIXAS P/ PISO COMPLETA 4X4 LATÃO		    NCM : 7609.0000	TAMPAS EM CHAPA DE LATÃO SEM EQUIPAMENTO (4X4) LATÃO		
	C/ Equipamento	Código		Descrição	Código	
	1 Tom Univ 2 Polos	CP-605		Cega	TP-616	
	1 Tom Telebras	CP-607		1 Unha Redonda	TP-619	
	1 Tom 2P+T	CP-606		1 Unha Quadrada	TP-620	
	2 Tom Univ 2 Polos	CP-604		2 Unhas Redondas	TP-618	
	1 Tom Univ + 1 Teleb	CP-608		2 Unhas Quadradas	TP-624	
	1 Tom Univ + 1 2P+T	CP-609		3 Tom RJ-45	TP-625	
	2 Tom Telebras	CP-610		CAIXA DE ALUMÍNIO		
	1 Tom 2P+T + 1 Teleb	CP-611		Medida	Entrada	Código
	2 Tom 2P+T	CP-612		4X2	3/4"	CX-613
	3 Tom Rj45 11 amp	CP-626	  NCM : 7609.0000	4X4		CX-614
CAIXAS P/ PISO E TAMPAS (inox)						
  NCM : 7609.0000	CAIXAS P/ PISO COMPLETA 4X2 (CAIXA + TAMPA + TOMADAS) INOX		  NCM : 7609.0000	TAMPAS EM CHAPA DE INOX SEM EQUIPAMENTO (4X2) INOX		
	C/ Equipamento	Código		Descrição	Código	
	1 Tom Univ 2 Polos	CP-601/INOX		Cega	TP-615/INOX	
	1 Tom Telebrás	CP-602/INOX		1 Unha Redonda	TP-617/INOX	
	1 Tom Univ 2P + T	CP-603/INOX		1 Unha Quadrada	TP-623/INOX	
	2 Tom RJ-45 11 amp	CP-628/INOX		2 Tom RJ-45	TP-627/INOX	
 NCM : 7609.0000	CAIXAS P/ PISO COMPLETA 4X4 INOX		    NCM : 7609.0000	TAMPAS EM CHAPA DE INOX SEM EQUIPAMENTO (4X4) INOX		
	C/ Equipamento	Código		Descrição	Código	
	1 Tom Univ 2 Polos	CP-605/INOX		Cega	TP-616/INOX	
	1 Tom Telebras	CP-607/INOX		1 Unha Redonda	TP-619/INOX	
	1 Tom 2P+T	CP-606/INOX		1 Unha Quadrada	TP-620/INOX	
	2 Tom Univ 2 Polos	CP-604/INOX		2 Unhas Redondas	TP-618/INOX	
	1 Tom Univ + 1 Teleb	CP-608/INOX		2 Unhas Quadradas	TP-624/INOX	
	1 Tom Univ + 1 2P+T	CP-609/INOX		3 Tom RJ-45	TP-625/INOX	
	2 Tom Telebras	CP-610/INOX				
	1 Tom 2P+T + 1 Teleb	CP-611/INOX				
	2 Tom 2P+T	CP-612/INOX				
	3 Tom Rj45 11 amp	CP-626/INOX				

ANOTAÇÕES
